

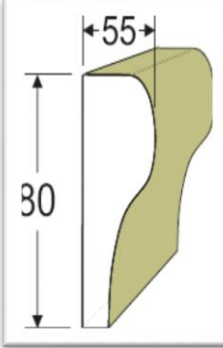

Profile Listwowe

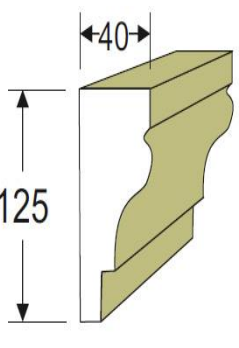
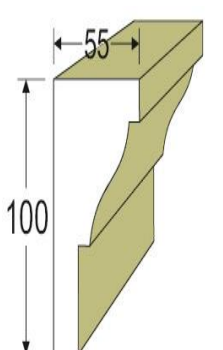
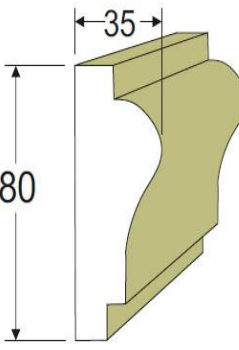
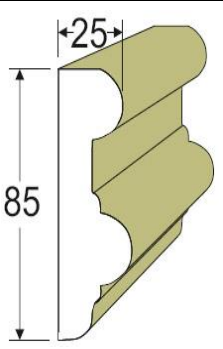
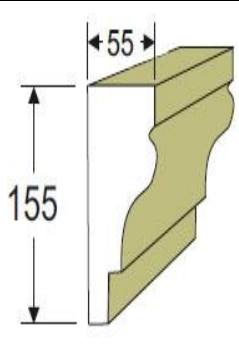
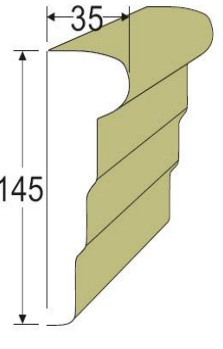
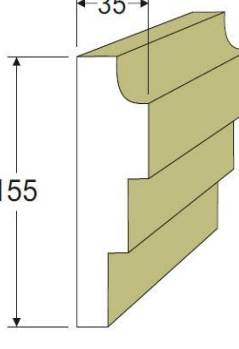
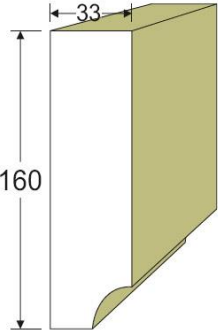
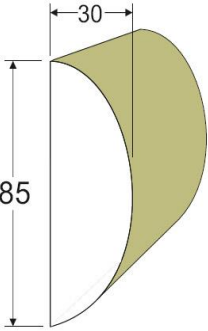
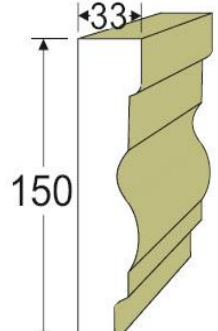
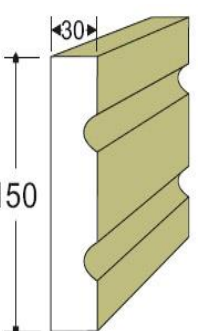
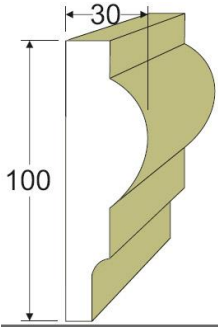
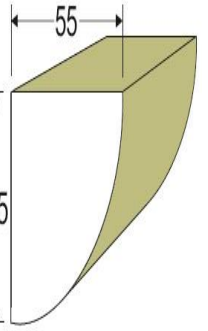

NUMER KATALOGOWY	Wymiary przekroju (mm)	Cena 1mb w PLN netto	OBRAZEK	NUMER KATALOGOWY	Wymiary przekroju (mm)	Cena 1mb w PLN netto	OBRAZEK
L111A	80X55	23		L001A	125X40	27	
L121A	100X55	28		L011A	80X35	21	
L131A	85X25	22		L021A	155X55	38	
L141A	145X35	27		L031A	155X35	31	

L2	85X34	24		L041A	80X30	19	
L3	125X25	28		L051A	125X45	29	
L4	125X30	29		L081A	70X30	21	
L5	35X140	32		L091A	140X30	31	
L6	35X125	30		L1	85X34	25	

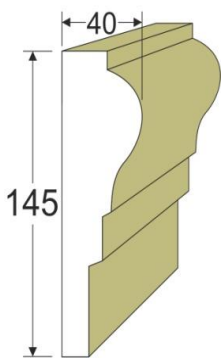
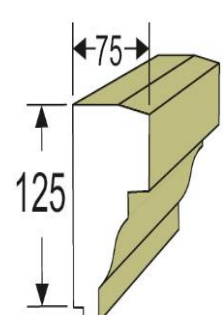
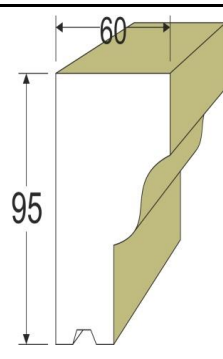
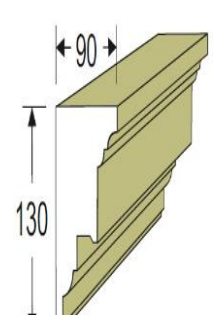
NUMER KATALOGOWY	Wymiary przekroju (mm)	Cena 1mb w PLN netto	OBRAZEK	NUMER KATALOGOWY	Wymiary przekroju (mm)	Cena 1mb w PLN netto	OBRAZEK
L7	33X160	35		L10	30X85	22	
L8	33X150	33		L101A	150X30	30	
L9	30X100	25		L11	55X55	25	

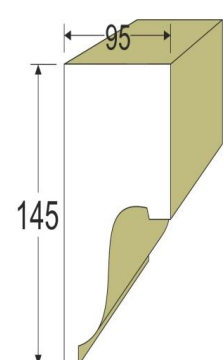
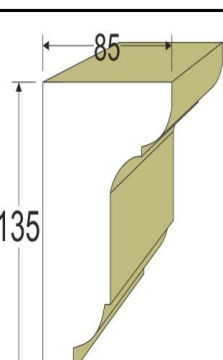
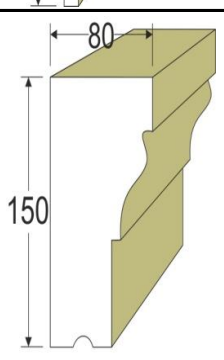
Profile Podparapetowe

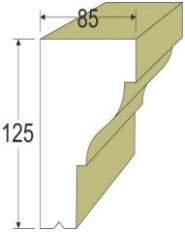
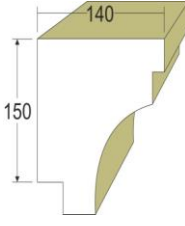
NUMER KATALOGOWY	Wymiary przekroju (mm)	Cena 1mb w PLN netto	OBRAZEK	NUMER KATALOGOWY	Wymiary przekroju (mm)	Cena 1mb w PLN netto	OBRAZEK
P12	145X40	35		P001A	125X75	34	
P121A	95X60	30		P011A	130X90	42	
P13	145X45	36		P021A	145X95	47	
P131A	135X85	40		P031A	150X80	43	

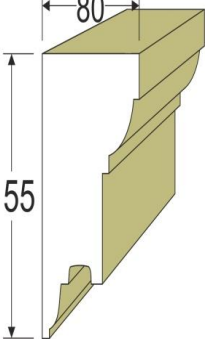
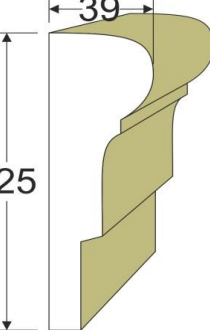
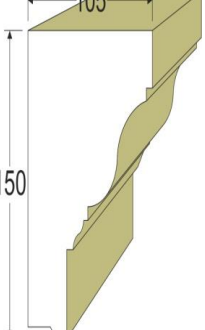
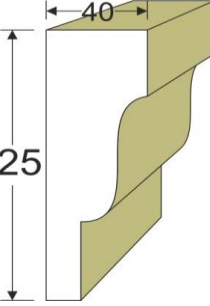
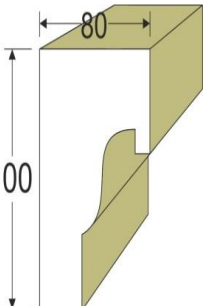
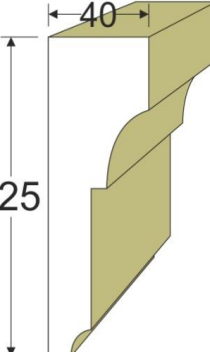
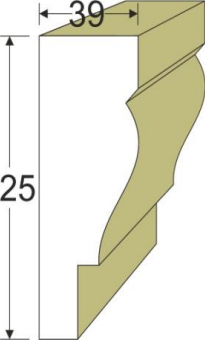
P14	125X85	45		P041A	150X140	56	
P15	125X45	33		P061A	155X80	42	
P2	125X39	32		P071A	150X105	43	
P3	125X40	32		P081A	100X80	34	
P4	125X40	32		P1	125X39	32	

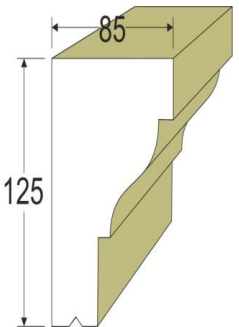
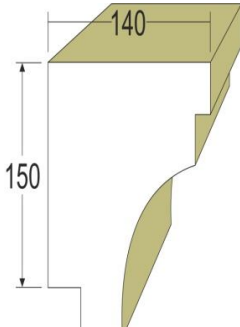
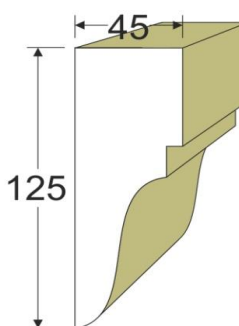
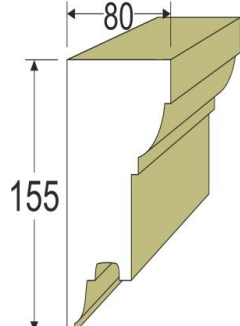
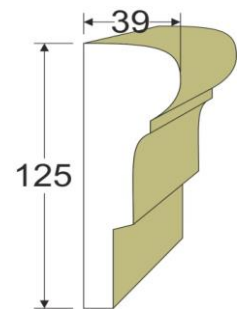
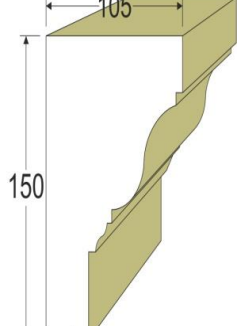
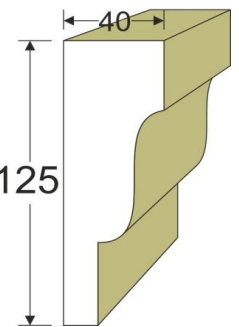
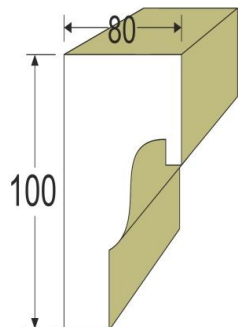
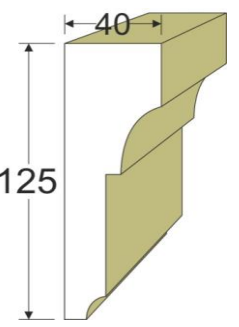
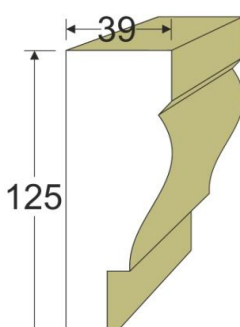
P14	125X85	45		P041A	150X140	56	
P15	125X45	33		P061A	155X80	42	
P2	125X39	32		P071A	150X105	43	
P3	125X40	32		P081A	100X80	34	
P4	125X40	32		P1	125X39	32	

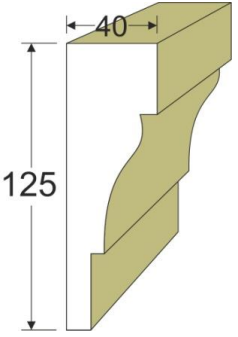
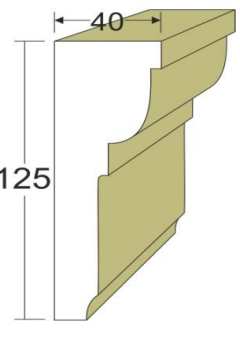
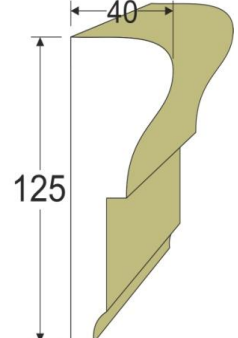
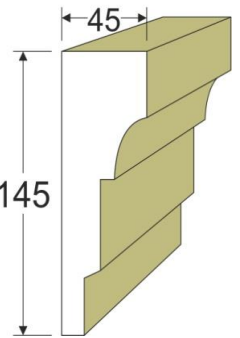
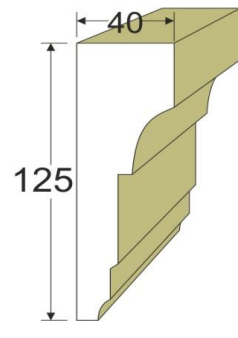
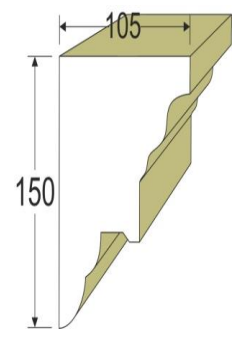
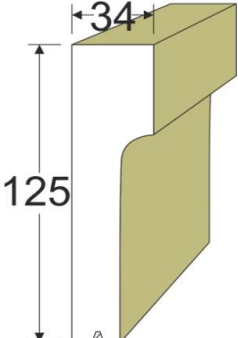
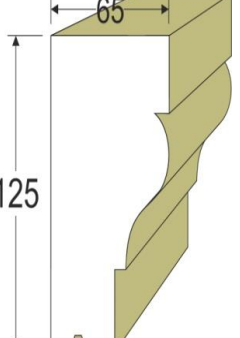
NUMER KATALOGOWY	Wymiary przekroju (mm)	Cena 1mb w PLN netto	OBRAZEK	NUMER KATALOGOWY	Wymiary przekroju (mm)	Cena 1mb w PLN netto	OBRAZEK
P5	125X40	32		P9	125X40	32	
P6	125X40	32		P10	145X45	36	
P7	125X40	32		P101A	150X105	43	
P8	125X34	30		P11	125X65	40	

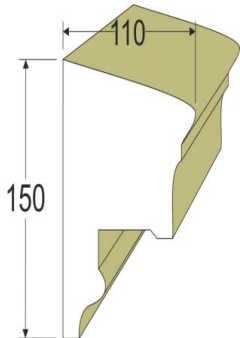
P111A	150X110	48	 A 3D perspective drawing of a metal part, likely a bracket or support. The part is colored in a light olive green. It features a top horizontal flange with a width of 110 units. The main vertical body of the part has a height of 150 units. The bottom edge of the part is stepped, with a lower section extending further out than the upper section. The drawing is shown from a three-quarter view, highlighting its L-shaped profile.
-------	---------	----	---

Gzymsy

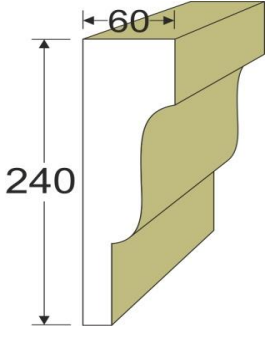
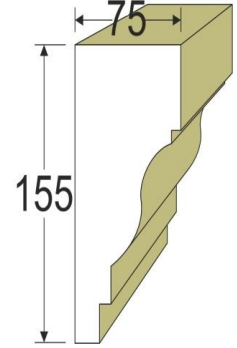
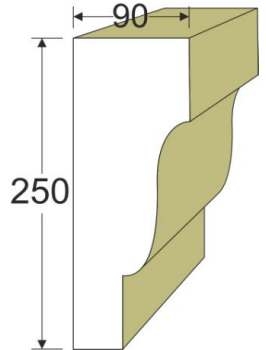
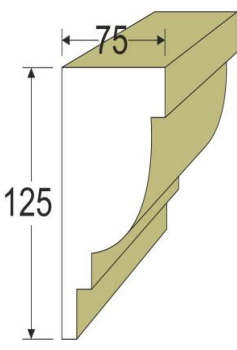
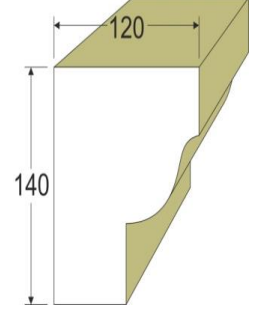
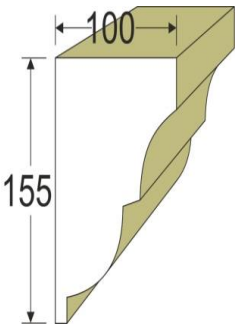
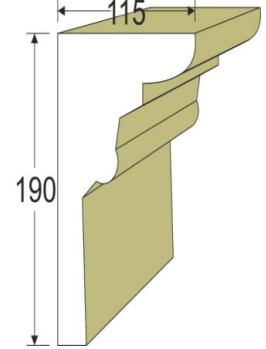
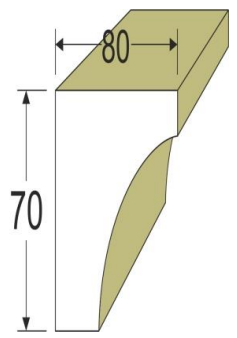
Gzymsy							
NUMER KATALOGOWY	Wymiary przekroju (mm)	Cena 1mb w PLN netto	OBRAZEK	NUMER KATALOGOWY	Wymiary przekroju (mm)	Cena 1mb w PLN netto	OBRAZEK
G15	150X60	67		G001A	155X75	38	
G16	250X90	66		G011A	125X75	35	
G17	120X140	58		G021A	155X100	46	
G18	115X190	65		G031A	70X80	31	

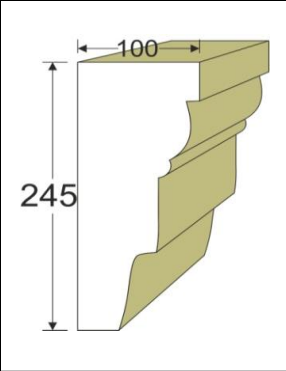
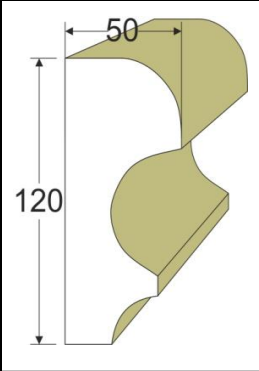
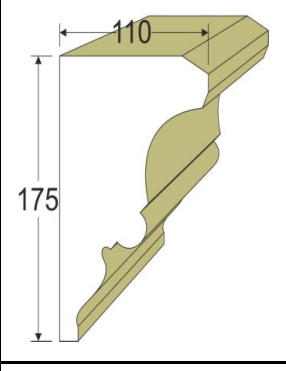
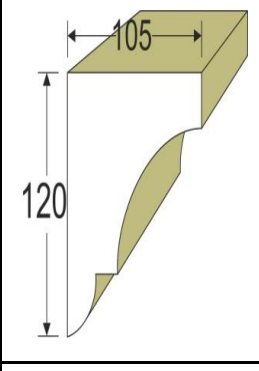
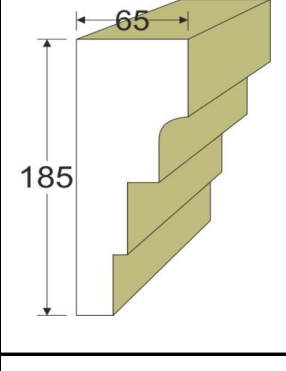
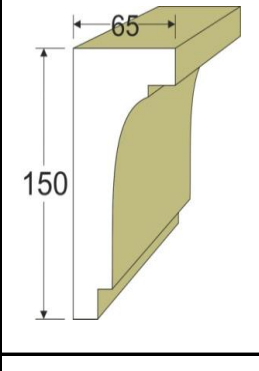
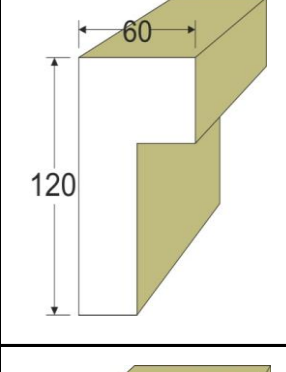
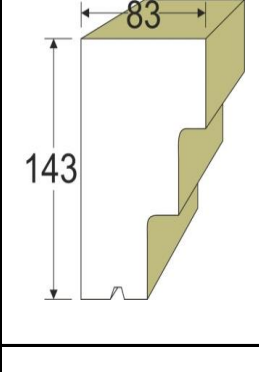
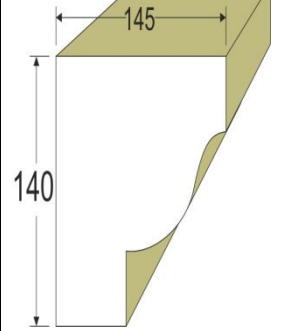
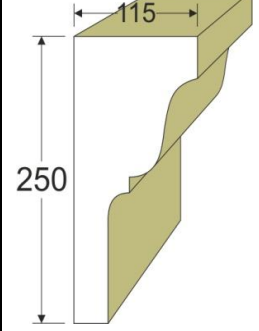
G19	100X245	69		G041A	120X50	30	
G2	175X110	60		G071A	120X105	41	
G20	65X185	48		G081A	150X65	36	
G21	60X120	37		G1	143X83	47	
G22	145X140	66		G10	250X115	74	

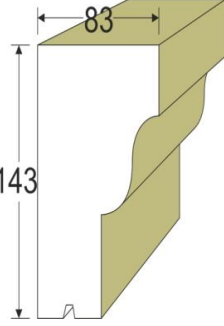
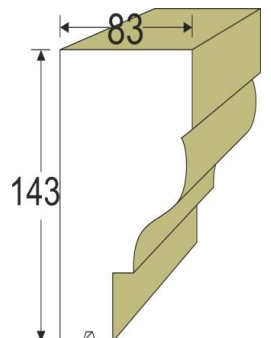
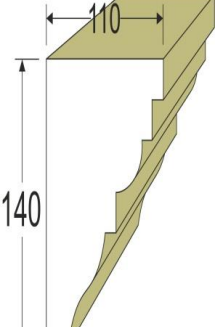
NUMER KATALOGOWY	Wymiary przekroju (mm)	Cena 1mb w PLN netto	OBRAZEK	NUMER KATALOGOWY	Wymiary przekroju (mm)	Cena 1mb w PLN netto	OBRAZEK
G3	143X120	59		G7	143X83	47	
G4	143X83	47		G101A	110X50	25	
G5	143X83	47		G11	255X155	87	
G6	140X120	58		G111A	140X110	44	

G12	150X55	54	<p>Technical drawing of profile G12. The height is 240 and the width is 55. The profile has a top flange, a vertical stem, and a bottom flange with a decorative profile.</p>
G13	250X150	85	<p>Technical drawing of profile G13. The height is 250 and the width is 150. The profile features a top flange, a vertical stem, and a bottom flange with a decorative profile.</p>
G8	140X120	58	<p>Technical drawing of profile G8. The height is 140 and the width is 120. The profile has a top flange, a vertical stem, and a bottom flange with a decorative profile.</p>
G9	165X110	59	<p>Technical drawing of profile G9. The height is 165 and the width is 110. The profile has a top flange, a vertical stem, and a bottom flange with a decorative profile.</p>
G14	150X90	64	<p>Technical drawing of profile G14. The height is 240 and the width is 90. The profile has a top flange, a vertical stem, and a bottom flange with a decorative profile.</p>

LISTWY PROSTE

OPIS

OBRAZEK

CENA: $(2h+s) \times 1.20 \text{ zł/mb netto}$ h,s -
wymiary w centymetrach

CENA: $(2h+s) \times 1.20 \text{ zł/mb netto}$ h,s -
wymiary w centymetrach. Przykład: dla
listwy 20x125mm $(2 \times 2.0 + 12.5)$
 $\times 1.20 = 19.80 \text{ zł/mb netto}$

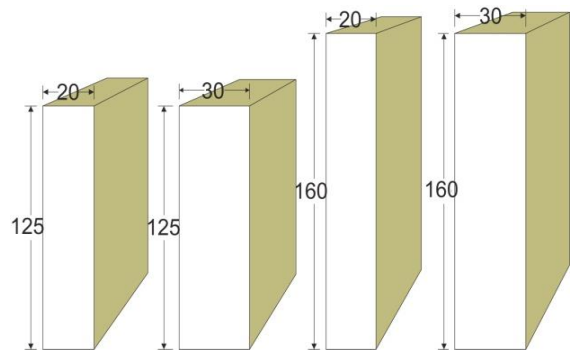

BONIE I LISTWY DO BONIOWANIA

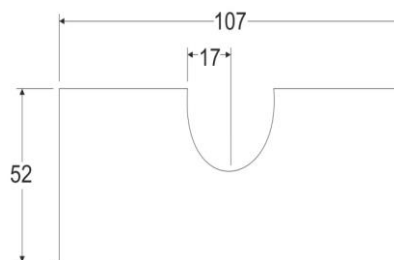

Cena 1mb 25zł netto

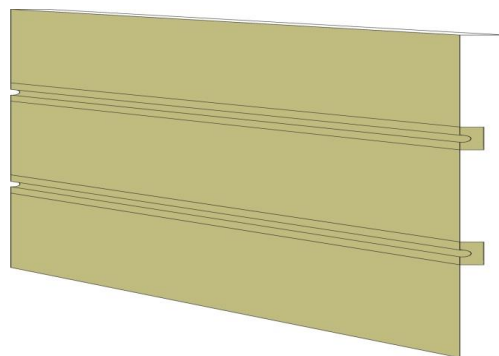

cena jednego kompletu 70zł netto

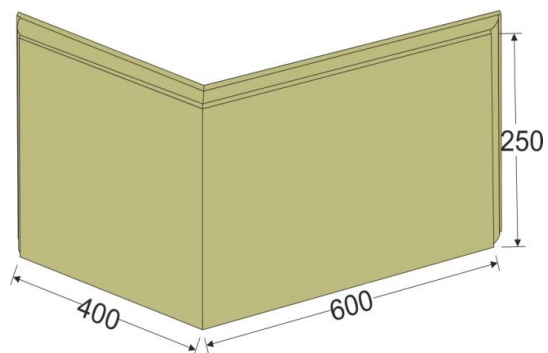

Przykładowe wzory przekroju boni narożnej

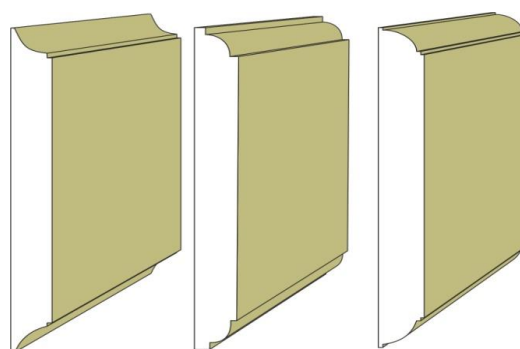

KOLUMNY, GŁOWICE, PILASTRY I OTULINY KOLUMN

OPIS

OBRAZEK

Otulina gładka, średnica wewnętrzna 300 mm, cena za 1 mb 200 zł netto

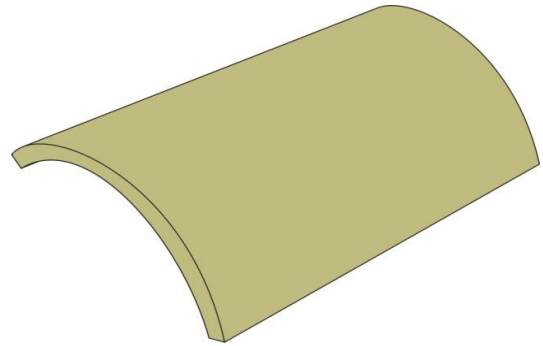

Otulina rowkowa
średnica zewnętrzna 300mm
cena za 1mb 350zł netto
Otuliny kolumn wykonujemy również o średnicach 200,250,300,350mm

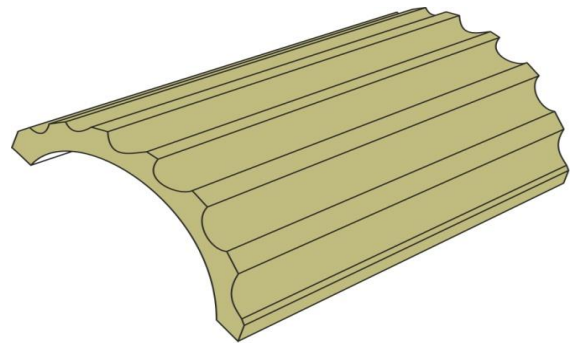

Przykładowy wymiar 300mm x 55mm
cena 1mb 80zł Wykonujemy dowolne wymiary i kształty pilastrów

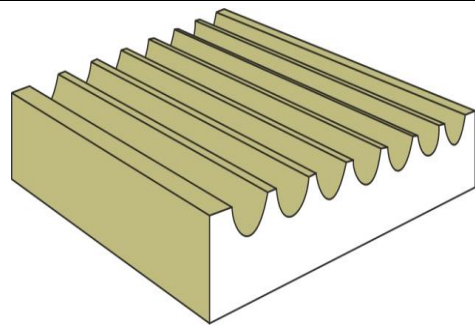

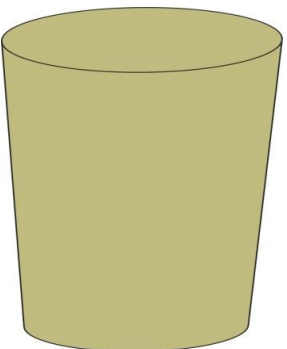
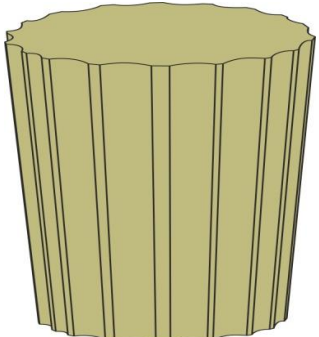
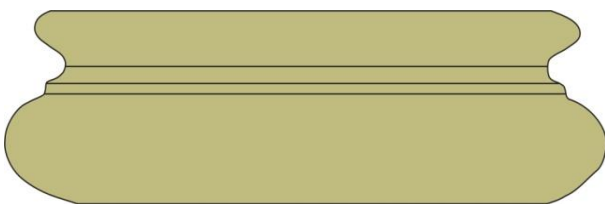
<p>Trzon gładki średnica zewnętrzna 370mm 1mb 200 zł netto</p>	
<p>Trzon rowkowy średnica zewnętrzna 370mm 1mb 350zł netto</p>	
<p>Średnica wewnętrzna 300mm- 150zł netto za 1 szt. Średnica wewnętrzna 250 mm 140zł netto za 1 szt. Średnica wewnętrzna 200mm- 130zł netto za 1 szt.</p>	

Łuki wokółokienne

OPIS

Obrazek

Indywidualna wycena

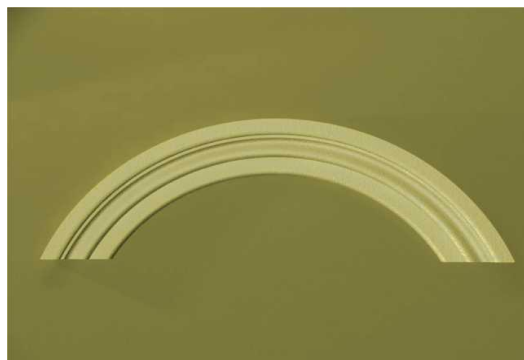

Wsporniki

OPIS

Obrazek

Cena netto 40zł za jedną sztukę

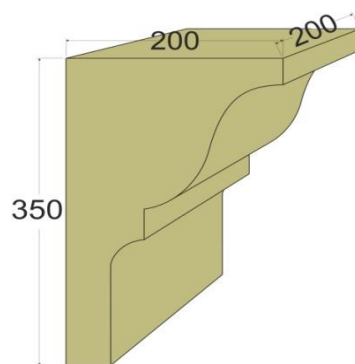

Zworniki

Opis

Obrazek

Cena netto:
z1 zwornik mały 45zł za sztukę
z2-zwornik średni 55zł za sztukę z3-
zwornik duży 65zł za sztukę

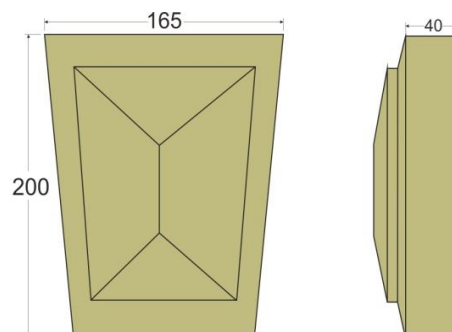

Zwornik z4 - Cena netto 45zł
za jedną sztukę

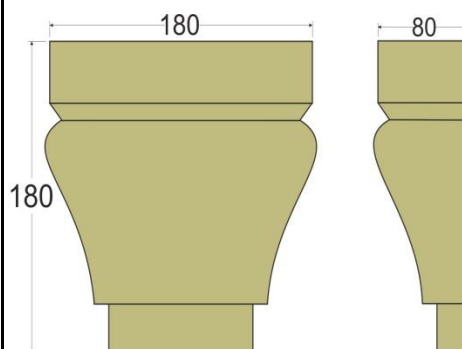

Zwornik z5 - cena netto 40zł
za jedną sztukę

